



Reeco
ESD Clothing

CONTENTS

INTRODUCTION

ABOUT REECO	3
CLOTHING MANUFACTURING	4 - 5
ANTISTATIC PROTECTIVE CLOTHING	6
ANTISTATIC FABRICS	7

ESD CLOTHING

T-SHIRT	8 - 11
LONG SLEEVE T-SHIRT	12 - 15
POLO SHIRT	16 - 19
LONG SLEEVE POLO SHIRT	20 - 23
POLO PIQUE SHIRT	24 - 27
LONG SLEEVE POLO PIQUE SHIRT	28 - 31
CLASSIC SWEATSHIRT	32 - 33
ZIP UP SWEATSHIRT	34 - 35
SOFTSHELL SWEATSHIRT	36 - 37
STANDARD COAT	38 - 41
PREMIUM COAT	42 - 43
TROUSERS	44 - 47

CLEANROOM CLOTHING

CLEAN ROOM COAT	50 - 51
CLEAN ROOM HOODED COAT	52 - 53
CLEAN ROOM COVERALL	54 - 55

WASHING INSTRUCTIONS	56
COOPERATION	57





ABOUT REECO

YEARS OF EXPERIENCE

We have more than 10 years of experience in the production and distribution of the specialist clothing.

During this time we have expanded our range of products and gained experience to provide our clients with comprehensive service in the field of ESD antistatic clothing.

RANGE OF ACTIVITY

We deliver REECO brand products directly to end users and companies specializing in maintenance and rental of protective clothing.

We also have an extensive network of distribution across Europe and in the United States of America.

4 BRANCHES IN EUROPE

All of our branches across Europe are equipped with DEMO ROOM, where we can present and test our products, proving its effectiveness and great quality.

What distinguishes us - personal commitment to client's needs.

1600 m² OF WAREHOUSE AREA

Logistics and warehouse staff, through close cooperation with other company departments, always have current knowledge about the status of each order. Our employees enable us to deliver order promptly and directly to you.

FAIRS AND CONFERENCES

We are advertising and promoting REECO clothing during various domestic and foreign conferences and fairs. You can meet us at Automaticon, Motek, Productronica and Industry Week.





CLOTHING MANUFACTURING

We know how important is the user comfort and safety when working with components and devices sensitive to electrostatic discharge, therefore we constantly take care of maintaining high standards during the clothing manufacturing. REECO ESD Antistatic clothing is produce in Poland under appropriate work conditions.

We constantly control the properties of our fabrics and accessories used for the production. The result is constant end product quality, verified at the stage of preparation, sewing and packing.

Reeco clothing can be washed and dried industrially. We have several years of experience in cooperation with leading industrial laundries.

STANDARDS

Clothing presented in our catalogue meets the requirements of following standards:

PN-EN 1149-5 | PN-EN ISO 13688 | PN-EN 61340-5-1

REECO ESD Antistatic clothing also meets the material requirements for protective clothing with electrostatic dissipating properties for EX areas. Ready product, after EHS Specialist prior approval can be used in the presence of flammable media, including methane and coal dust.

PERSONALIZED CLOTHING

We offer complete personalization of REECO ESD Antistatic clothing with possibility of embroidery of Customer's logo and name. We also provide thermal labels allowing for easy identification of clothing by employees.

ANTISTATIC PROTECTIVE CLOTHING

According to international research about 70% of damages of electronic components are caused by inappropriate personnel protection.

Human is primary charges generator.

Therefore, the main method of protection against electrostatic discharges becomes antistatic clothing. Very widespread mistake is belief about efficient ESD protection by using wrist strap.

While all international standards, including EN 61340-5-1, stresses necessity of using special clothing directly at workplace and in all EPA zones.



USE OF ANTISTATIC CLOTHING
IS ONE OF THE MOST EFFECTIVE
METHODS OF PROTECTION AGAINST
ELECTROSTATIC DISCHARGE



ANTISTATIC FABRICS

All of the fabrics that we use have been tested for their applicable antistatic standards by Textile Research Institute. We provide several types of fabrics different due to the structure, composition and color. All of the fabrics are characterized by high durability and color stability.

FABRIC 065

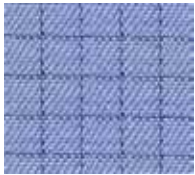

COMPOSITION:

Cotton 34 %
Polyester 64 %
Carbon fiber 2 %

WEIGHT:

150 g/m²

FABRIC 099

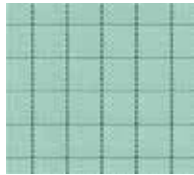

COMPOSITION:

Polyester 99 %
Carbon fiber 1 %

WEIGHT:

110 g/m²

PIQUE KNIT FABRIC



COMPOSITION:

Cotton 98 %
Carbon fiber 2 %

WEIGHT:

160 g/m²

KNIT FABRIC 050



COMPOSITION:

Cotton 49 %
Polyester 49 %
Carbon fiber 2 %

WEIGHT:

180 g/m²

KNIT FABRIC 260

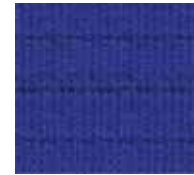

COMPOSITION:

Cotton 49 %
Polyester 49 %
Carbon fiber 2 %

WEIGHT:

260 g/m²

KNIT FABRIC 95

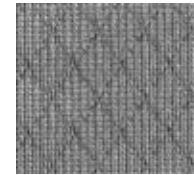

COMPOSITION:

Polyester 95 %
Carbon fiber 5 %

WEIGHT:

100 g/m²

FABRIC SOFTSHELL

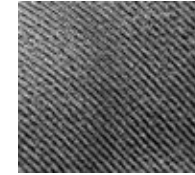

COMPOSITION:

Polyester 96 %
Carbon fiber 4 %

WEIGHT:

300 g/m²

COLOR MATCHING

We did our best to present printed colors as similar as possible to the actual colors, however we would like to inform that printed and electronic colors do not give a fully accurate representation of the actual colors of the clothing.

49%

COTTON

49%

POLYESTER

2%

CARBON FIBER

Product code:
CE-TSHIR.050.D



RESISTANCE IN ACCORDANCE
WITH STANDARD

PN-EN 61340-5-1



WEIGHT

180 g/m²



WOMEN'S T-SHIRT

DESCRIPTION





Fabric	KNIT FABRIC 050
Cut	FEMALE
Sizes	2XS - 2XL
ESD sign	SIDE TAG

OPTIONS





Custom size	BESPOKE
Custom color	BESPOKE
Customer's logo	EMBROIDERY

AVAILABLE COLOURS | KNIT FABRIC 050

STANDARD

				
Navy blue	Black	White	Blue	Red
25	27	28	30	39

NON-STANDARD

				
Orange	Dark grey	Lemon green	Dark green	Neon yellow
38	40	42	54	55

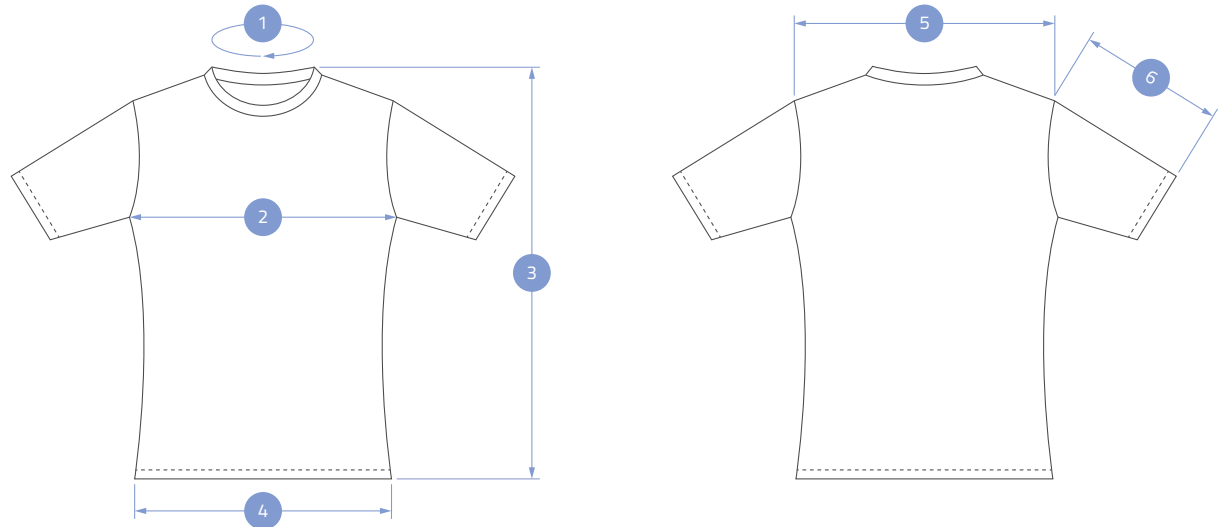

	2XS	XS	S	M	L	XL	2XL
BODY							
1	36	37	37	39	39	41	41
2	45	47	49	51	54	57	60
3	69	70	71	72	73	74	74
4	49	51	53	55	58	61	64
5	34	35	36	37	38	40	40
SLEEVES							
6	20	21	21	22	23	23	23

Dimensions in centimeters (cm) | Dimensional tolerance +/- 1.5 cm

49%

COTTON

49%

POLYESTER

2%

CARBON FIBER



RESISTANCE IN ACCORDANCE
WITH STANDARD

PN-EN 61340-5-1



WEIGHT

180 g/m²

Product code:
CE-TSHIRT.050



MEN'S T-SHIRT

DESCRIPTION

Fabric	KNIT FABRIC 050
Cut	MALE
Sizes	2XS - 2XL
ESD sign	SIDE TAG

OPTIONS

Custom size	BESPOKE
Custom color	BESPOKE
Customer's logo	EMBROIDERY

AVAILABLE COLOURS | KNIT FABRIC 050

STANDARD



Navy blue	Black	White	Blue	Red
25	27	28	30	39

NON-STANDARD



Orange	Dark grey	Lemon green	Dark green	Neon yellow
38	40	42	54	55

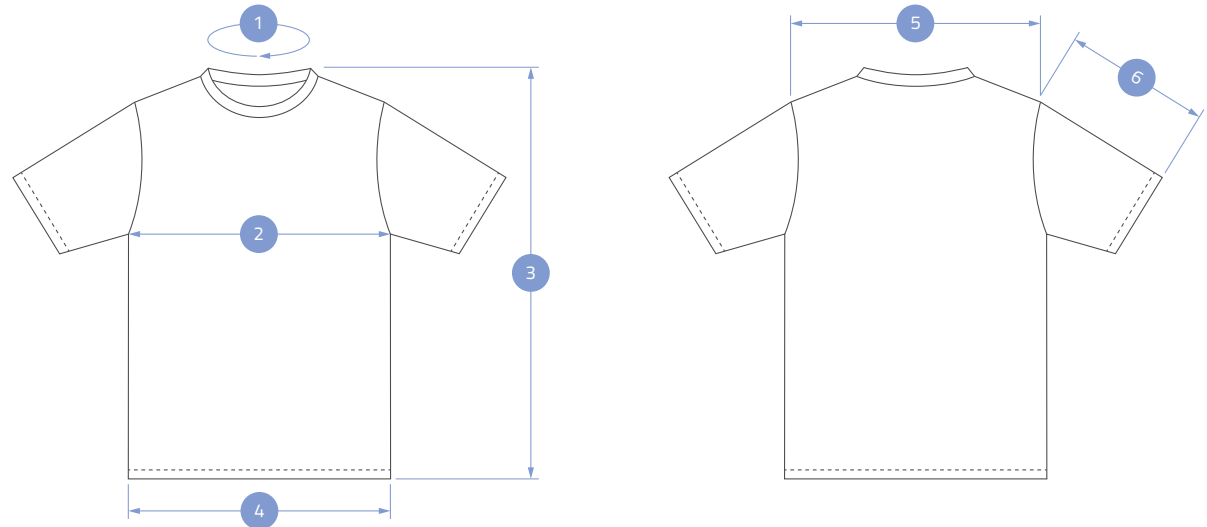

	2XS	XS	S	M	L	XL	2XL
BODY							
1	40	41	41	43	45	48	49
2	46	49	52	55	58	61	64
3	66	67	68	68	70	70	72
4	46	49	52	55	58	61	64
5	47	48	49	50	51	52	53
SLEEVES							
6	22	22	22	23	23	24	25

Dimensions in centimeters (cm) | Dimensional tolerance +/- 1.5 cm

49%

COTTON

49%

POLYESTER

2%

CARBON FIBER



RESISTANCE IN ACCORDANCE
WITH STANDARD

PN-EN 61340-5-1



WEIGHT

180 g/m²

Product code:

CE-TSHIR.050.D.LS



WOMEN'S LONG SLEEVE T-SHIRT

DESCRIPTION

Fabric	KNIT FABRIC 050
Cut	FEMALE
Sizes	2XS - 2XL
Sleeves	RIB CUFF
ESD sign	SIDE TAG

OPTIONS

Custom size	BESPOKE
Custom color	BESPOKE
Customer's logo	EMBROIDERY

AVAILABLE COLOURS | KNIT FABRIC 050

STANDARD



Navy blue	Black	White	Blue	Red
25	27	28	30	39

NON-STANDARD



Orange	Dark grey	Lemon green	Dark green	Neon yellow
38	40	42	54	55

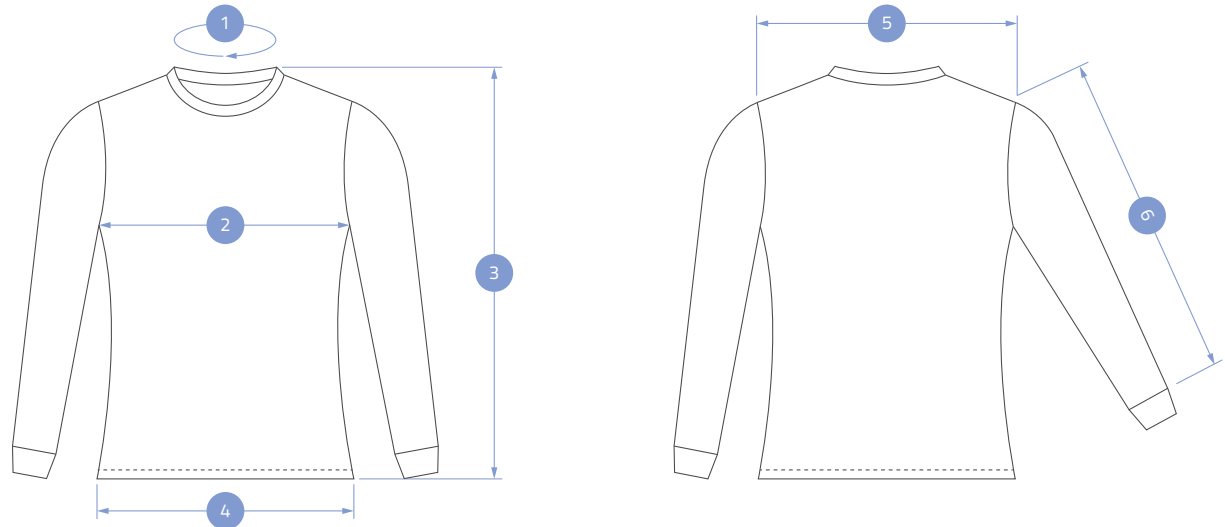

	2XS	XS	S	M	L	XL	2XL
BODY							
1	36	37	37	39	39	41	41
2	45	47	49	51	54	57	60
3	69	70	71	72	73	74	74
4	49	51	53	55	58	61	64
5	34	35	36	37	38	40	40
SLEEVES							
6	59	60	61	62	63	64	65

Dimensions in centimeters (cm) | Dimensional tolerance +/- 1.5 cm

49%
COTTON

49%
POLYESTER

2%
CARBON FIBER

Product code:
CE-TSHIR.050.LS



RESISTANCE IN ACCORDANCE
WITH STANDARD
PN-EN 61340-5-1



WEIGHT
180 g/m²



MEN'S LONG SLEEVE T-SHIRT

DESCRIPTION

Fabric	KNIT FABRIC 050
Cut	MALE
Sizes	2XS - 2XL
Sleeves	RIB CUFF
ESD sign	SIDE TAG

OPTIONS

Custom size	BESPOKE
Custom color	BESPOKE
Customer's logo	EMBROIDERY

AVAILABLE COLOURS | KNIT FABRIC 050

STANDARD



Navy blue	Black	White	Blue	Red
25	27	28	30	39

NON-STANDARD



Orange	Dark grey	Lemon green	Dark green	Neon yellow
38	40	42	54	55

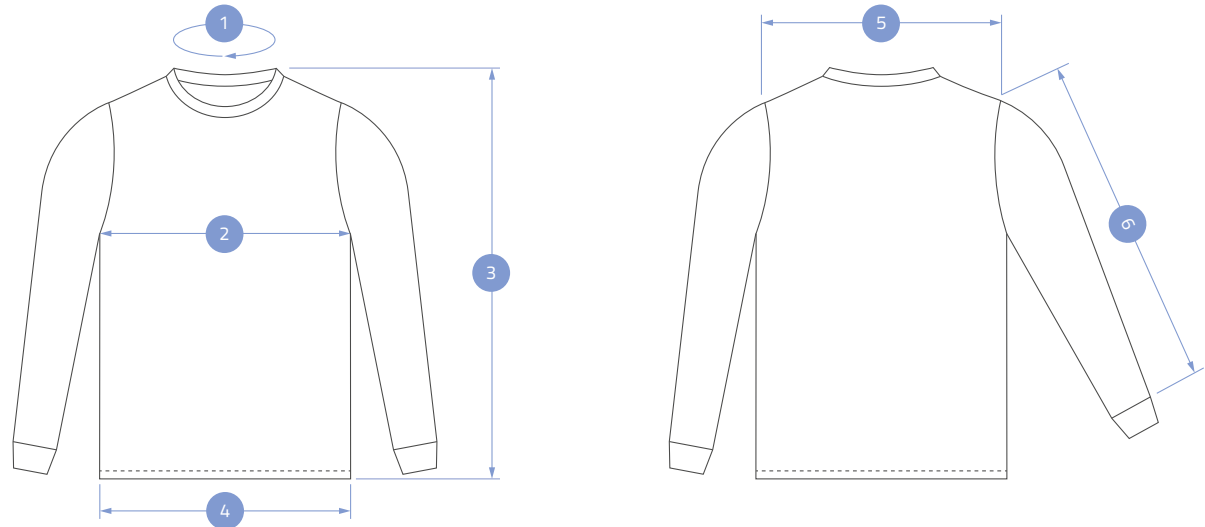

	2XS	XS	S	M	L	XL	2XL
BODY							
1	40	41	41	43	45	48	49
2	46	49	52	55	58	61	64
3	66	67	68	68	70	70	72
4	46	49	52	55	58	61	64
5	47	48	49	50	51	52	53
SLEEVES							
6	66	66	68	68	70	70	74

Dimensions in centimeters (cm) | Dimensional tolerance +/- 1.5 cm

49%

COTTON

49%

POLYESTER

2%

CARBON FIBER



RESISTANCE IN ACCORDANCE
WITH STANDARD

PN-EN 61340-5-1



WEIGHT

180 g/m²

Product code:
CE-POLO.050.D



WOMEN'S POLO SHIRT

DESCRIPTION

Fabric	KNIT FABRIC 050
Cut	FEMALE
Sizes	2XS - 2XL
Fastener	THREE BUTTONS
Pockets	ONE ON THE LEFT BREAST
ESD sign	SITE TAG

OPTIONS

Custom size	BESPOKE
Custom color	BESPOKE
Customer's logo	EMBROIDERY

AVAILABLE COLOURS | KNIT FABRIC 050

STANDARD

Navy blue	Black	White	Blue	Red
25	27	28	30	39

NON-STANDARD

Orange	Dark grey	Lemon green	Dark green	Neon yellow
38	40	42	54	55

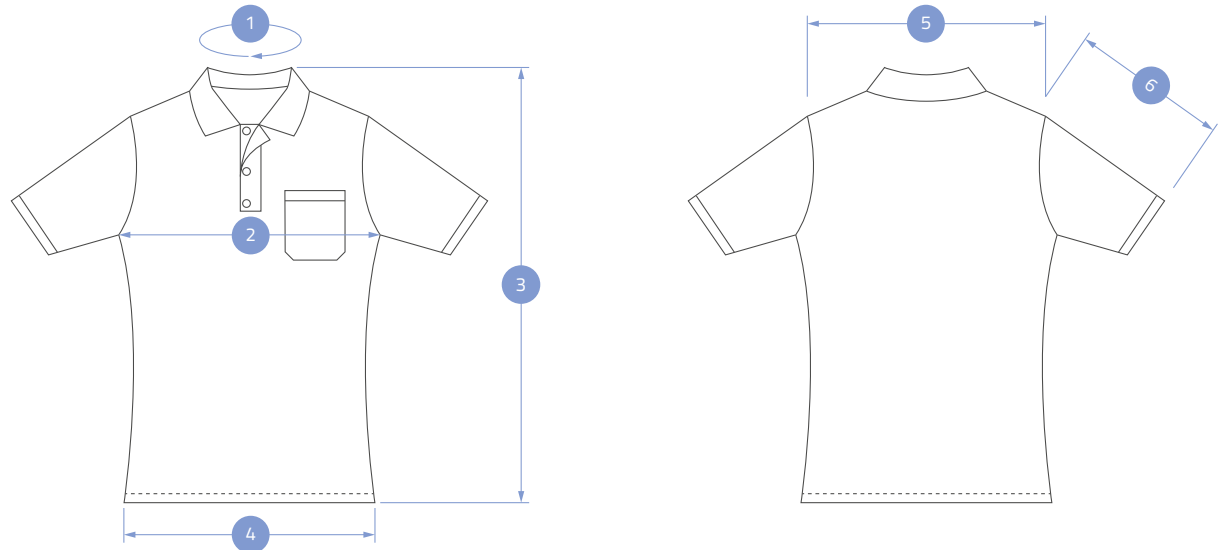

	2XS	XS	S	M	L	XL	2XL
BODY							
1	38	38	38	40	40	42	42
2	45	47	49	51	54	57	60
3	69	70	71	72	73	74	74
4	49	51	53	55	58	61	64
5	34	35	36	37	38	40	40
SLEEVES							
6	22	23	23	24	24	25	25

Dimensions in centimeters (cm) | Dimensional tolerance +/- 1.5 cm

49%

COTTON

49%

POLYESTER

2%

CARBON FIBER

Product code:
CE-POLO.050



RESISTANCE IN ACCORDANCE
WITH STANDARD

PN-EN 61340-5-1



WEIGHT

180 g/m²



MEN'S POLO SHIRT

DESCRIPTION

Fabric	KNIT FABRIC 050
Cut	MALE
Sizes	2XS - 2XL
Fastener	THREE BUTTONS
Pockets	ONE ON THE LEFT BREAST
ESD sign	SIDE TAG

OPTIONS

Custom size	BESPOKE
Custom color	BESPOKE
Customer's logo	EMBROIDERY

AVAILABLE COLOURS | KNIT FABRIC 050

STANDARD

Navy blue	Black	White	Blue	Red
25	27	28	30	39

NON-STANDARD

Orange	Dark grey	Lemon green	Dark green	Neon yellow
38	40	42	54	55

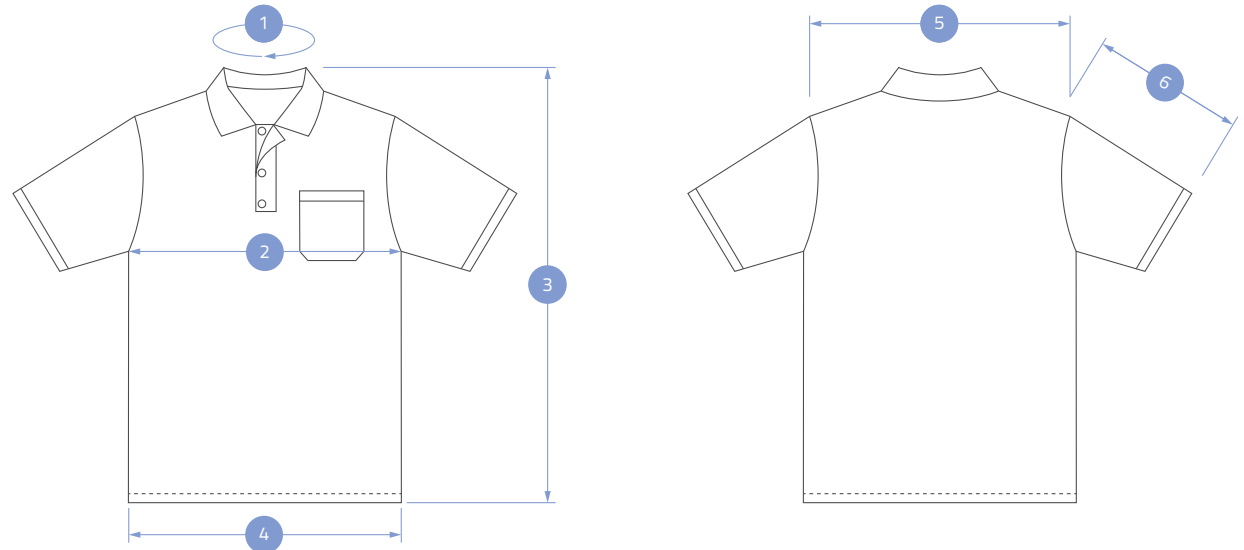

	2XS	XS	S	M	L	XL	2XL
BODY							
1	38	38	38	40	40	42	42
2	47	50	54	58	62	66	70
3	68	68	70	71	73	74	74
4	47	50	54	58	62	66	70
5	45	46	48	50	52	54	55
SLEEVES							
6	24	24	24	26	26	27	27

Dimensions in centimeters (cm) | Dimensional tolerance +/- 1.5 cm

49%

COTTON

49%

POLYESTER

2%

CARBON FIBER



RESISTANCE IN ACCORDANCE
WITH STANDARD

PN-EN 61340-5-1



WEIGHT

180 g/m²

Product code:

CE-POLO.050.D.LS



WOMEN'S LONG SLEEVE POLO SHIRT

DESCRIPTION

Fabric	KNIT FABRIC 050
Cut	FEMALE
Sizes	2XS - 2XL
Fastener	THREE BUTTONS
Pockets	ONE ON THE LEFT BREAST
Sleeves	RIB CUFF
ESD sign	SITE TAG

OPTIONS

Custom size	BESPOKE
Custom color	BESPOKE
Customer's logo	EMBROIDERY

AVAILABLE COLOURS | KNIT FABRIC 050

STANDARD

Navy blue	Black	White	Blue	Red
25	27	28	30	39

NON-STANDARD

Orange	Dark grey	Lemon green	Dark green	Neon yellow
38	40	42	54	55

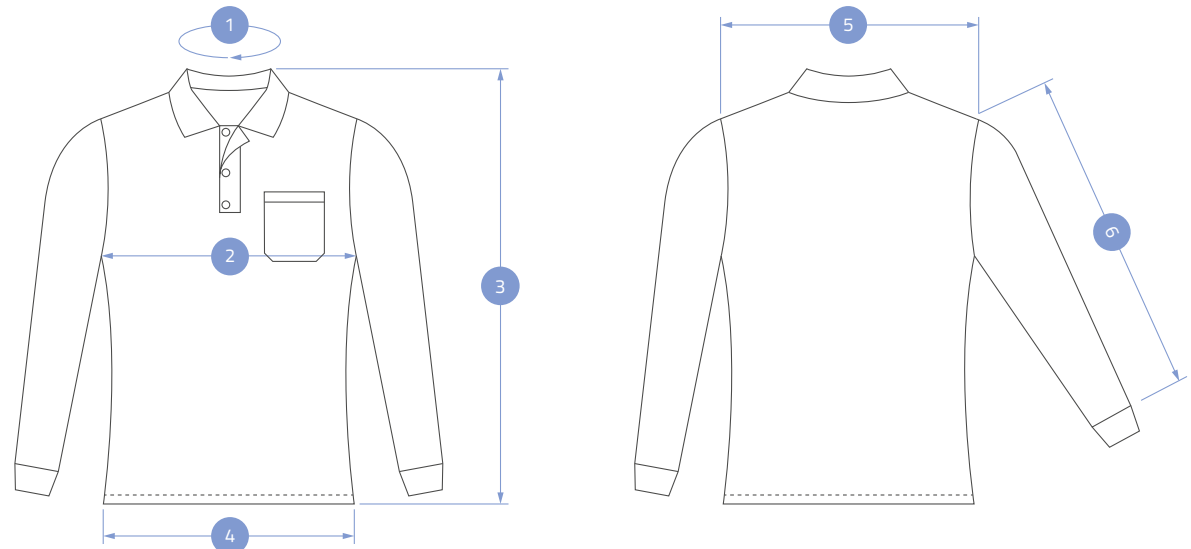

	2XS	XS	S	M	L	XL	2XL
BODY							
1	38	38	38	40	40	42	42
2	45	47	49	51	54	57	60
3	59	70	71	72	73	74	74
4	49	51	53	55	58	61	64
5	34	35	36	37	38	40	40
SLEEVES							
6	59	60	61	62	63	64	65

Dimensions in centimeters (cm) | Dimensional tolerance +/- 1.5 cm

49%

COTTON

49%

POLYESTER

2%

CARBON FIBER

Product code:
CE-POLO.050.LS



RESISTANCE IN ACCORDANCE
WITH STANDARD

PN-EN 61340-5-1



WEIGHT

180 g/m²



MEN'S LONG SLEEVE POLO SHIRT

DESCRIPTION

Fabric	KNIT FABRIC 050
Cut	MALE
Sizes	2XS - 2XL
Fastener	THREE BUTTONS
Pockets	ONE ON THE LEFT BREAST
Sleeves	RIB CUFF
ESD sign	SIDE TAG

OPTIONS

Custom size	BESPOKE
Custom color	BESPOKE
Customer's logo	EMBROIDERY

AVAILABLE COLOURS | KNIT FABRIC 050

STANDARD



Navy blue	Black	White	Blue	Red
25	27	28	30	39

NON-STANDARD



Orange	Dark grey	Lemon green	Dark green	Neon yellow
38	40	42	54	55

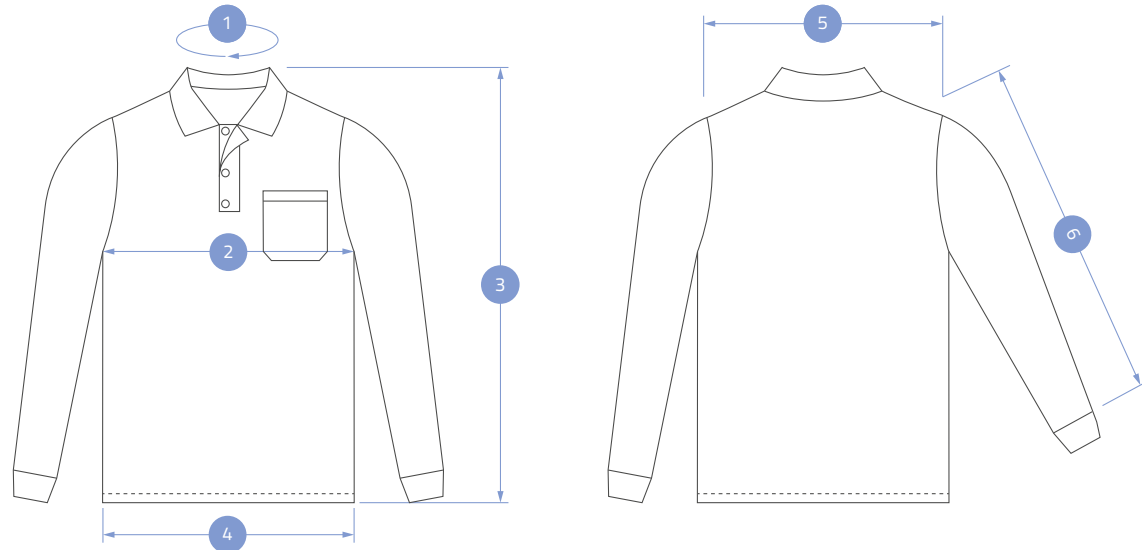

	2XS	XS	S	M	L	XL	2XL
BODY							
1	38	38	38	40	40	42	42
2	47	50	54	58	62	66	70
3	68	68	70	71	73	74	74
4	47	50	54	58	62	66	70
5	45	46	48	50	52	54	55
SLEEVES							
6	58	58	60	60	62	62	64

Dimensions in centimeters (cm) | Dimensional tolerance +/- 1.5 cm

98%

COTTON

2%

CARBON FIBER



RESISTANCE IN ACCORDANCE
WITH STANDARD

PN-EN 61340-5-1



WEIGHT

160 g/m²

Product code:
CE-POLO.PIKA.D



WOMEN'S POLO SHIRT PIQUE

DESCRIPTION

Fabric	PIQUE KNIT FABRIC
Cut	FEMALE
Sizes	2XS - 2XL
Fastener	THREE BUTTONS
Pockets	ONE ON THE LEFT BREAST
ESD sign	SIDE TAG

OPTIONS

Custom size	BESPOKE
Custom color	BESPOKE
Customer's logo	EMBROIDERY

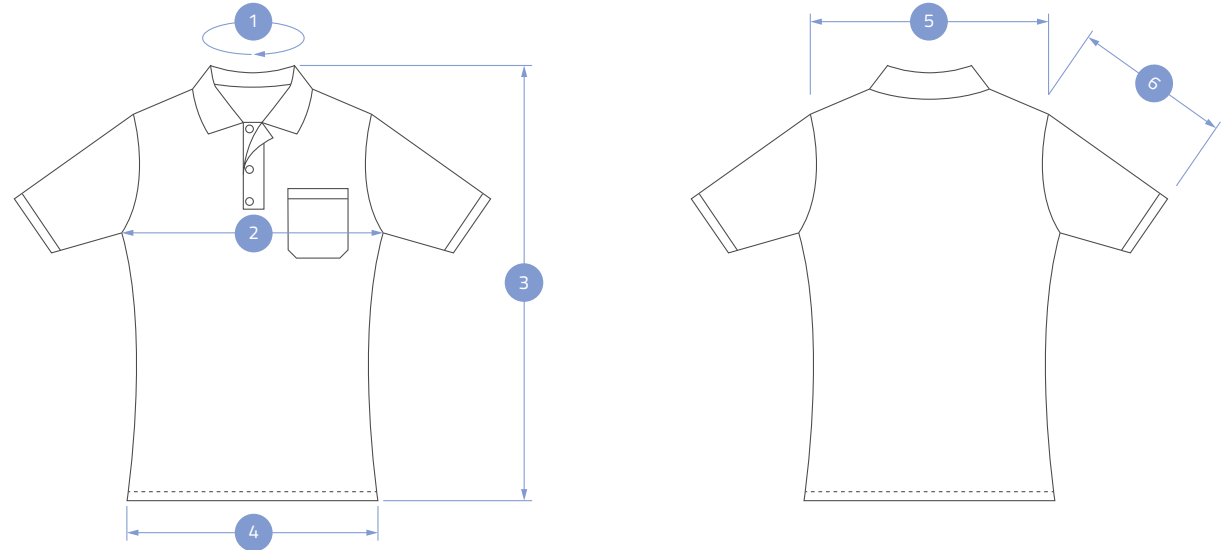

AVAILABLE COLOURS | PIQUE KNIT FABRIC



Blue	Navy blue	Black	Turquoise
19	20	23	33

	2XS	XS	S	M	L	XL	2XL
BODY							
1	38	38	38	40	40	42	42
2	45	47	49	51	54	57	60
3	69	70	71	72	73	74	74
4	49	51	53	55	58	61	64
5	34	35	36	37	38	40	40
SLEEVES							
6	22	23	23	24	24	25	25

Dimensions in centimeters (cm) | Dimensional tolerance +/- 1.5 cm

98%

COTTON

2%

CARBON FIBER



RESISTANCE IN ACCORDANCE
WITH STANDARD

PN-EN 61340-5-1



WEIGHT

160 g/m²

Product code:
CE-POLO.PIKA



MEN'S POLO SHIRT PIQUE

DESCRIPTION

Fabric	PIQUE KNIT FABRIC
Cut	MALE
Sizes	2XS - 2XL
Fastener	THREE BUTTONS
Pockets	ONE ON THE LEFT BREAST
ESD sign	SIDE TAG

OPTIONS

Custom size	BESPOKE
Custom color	BESPOKE
Customer's logo	EMBROIDERY

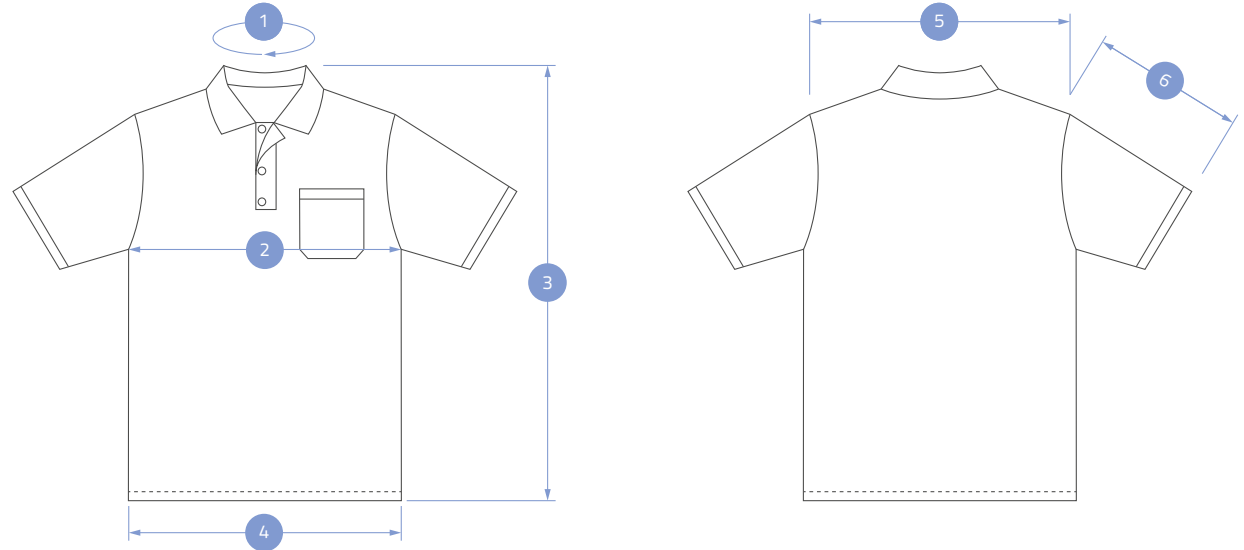

AVAILABLE COLOURS | PIQUE KNIT FABRIC



Blue	Navy blue	Black	Turquoise
19	20	23	33

	2XS	XS	S	M	L	XL	2XL
BODY							
1	38	38	38	40	40	42	42
2	47	50	54	58	62	66	70
3	68	68	70	71	73	74	74
4	47	50	54	58	62	66	70
5	45	46	48	50	52	54	55
SLEEVES							
6	24	24	24	26	26	27	27

Dimensions in centimeters (cm) | Dimensional tolerance +/- 1.5 cm

98%

COTTON

2%

CARBON FIBER



RESISTANCE IN ACCORDANCE
WITH STANDARD

PN-EN 61340-5-1



WEIGHT

160 g/m²

Product code:

CE-POLO.PIKA.D.LS



WOMEN'S LONG SLEEVE POLO SHIRT PIQUE

DESCRIPTION

Fabric	PIQUE KNIT FABRIC
Cut	FEMALE
Sizes	2XS - 2XL
Fastener	THREE BUTTONS
Pockets	ONE ON THE LEFT BREAST
Sleeves	RIB CUFF
ESD sign	SIDE TAG

OPTIONS

Custom size	BESPOKE
Custom color	BESPOKE
Customer's logo	EMBROIDERY

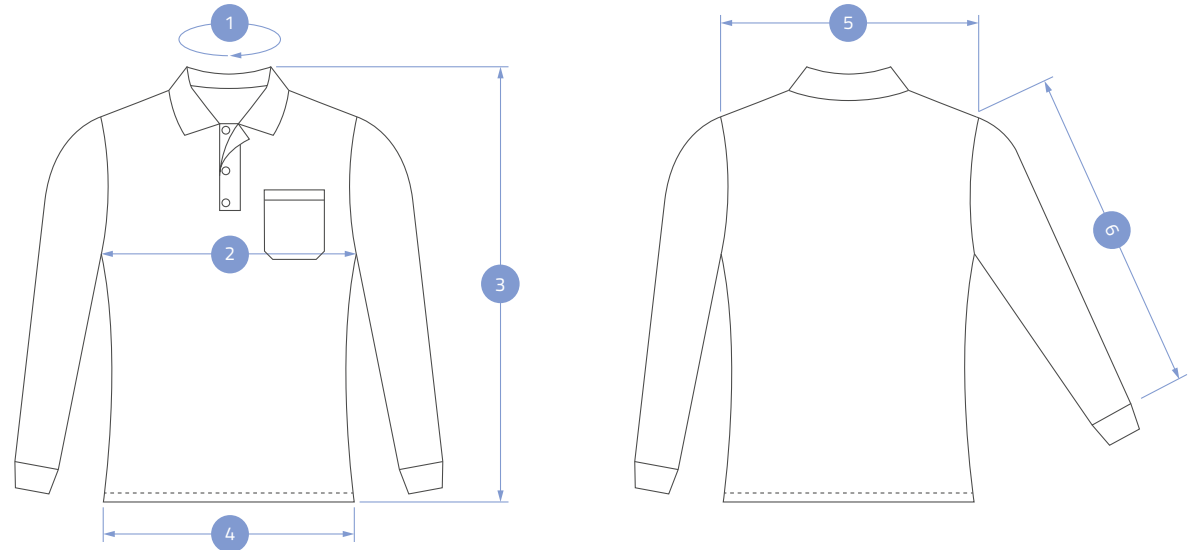

AVAILABLE COLOURS | PIQUE KNIT FABRIC



Blue	Navy blue	Black	Turquoise
19	20	23	33

	2XS	XS	S	M	L	XL	2XL
BODY							
1	38	38	38	40	40	42	42
2	45	47	49	51	54	57	60
3	69	70	71	72	73	74	74
4	49	51	53	55	58	61	64
5	34	35	36	37	38	40	40
SLEEVES							
6	59	60	61	62	63	64	65

Dimensions in centimeters (cm) | Dimensional tolerance +/- 1.5 cm

98%

COTTON

2%

CARBON FIBER



RESISTANCE IN ACCORDANCE
WITH STANDARD

PN-EN 61340-5-1



WEIGHT

160 g/m²

Product code:
CE-POLO.PIKA.LS



MEN'S LONG SLEEVE POLO SHIRT PIQUE

DESCRIPTION

Fabric	PIQUE KNIT FABRIC
Cut	MALE
Sizes	2XS - 2XL
Fastener	THREE BUTTONS
Pockets	ONE ON THE LEFT BREAST
Sleeves	RIB CUFF
ESD sign	SIDE TAG

OPTIONS

Custom size	BESPOKE
Custom color	BESPOKE
Customer's logo	EMBROIDERY

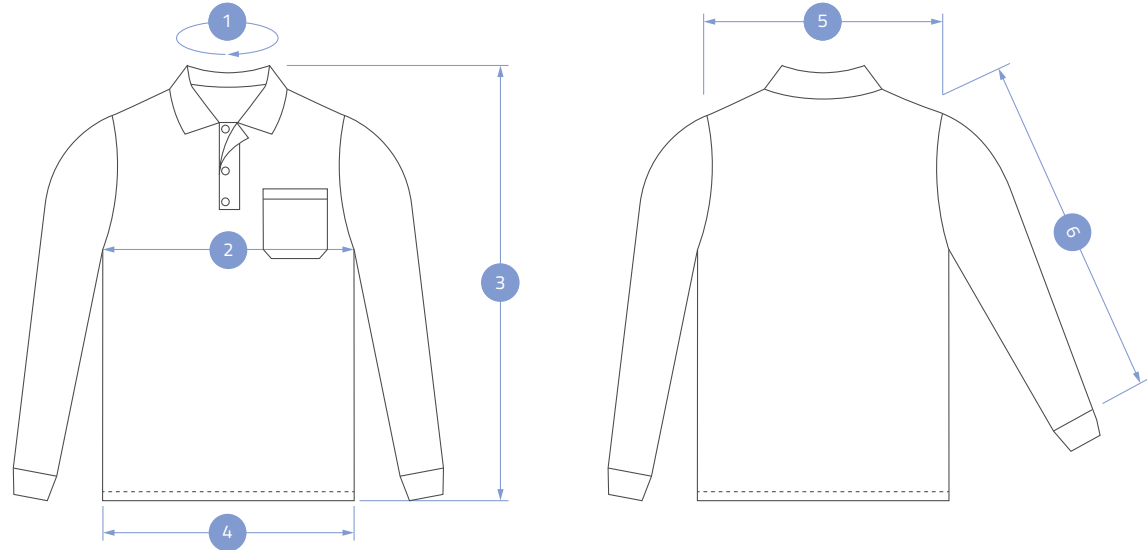

AVAILABLE COLOURS | PIQUE KNIT FABRIC



Blue	Navy blue	Black	Turquoise
19	20	23	33

	2XS	XS	M	L	XL	2XL	
BODY							
1	38	38	38	40	40	42	42
2	47	50	54	58	62	66	70
3	68	68	70	71	73	74	74
4	47	50	54	58	62	66	70
5	45	46	48	50	52	54	55
SLEEVES							
6	58	58	60	60	62	62	64

Dimensions in centimeters (cm) | Dimensional tolerance +/- 1.5 cm

49%

COTTON

49%

POLYESTER

2%

CARBON FIBER



RESISTANCE IN ACCORDANCE
WITH STANDARD

PN-EN 61340-5-1



WEIGHT

260 g/m²

Product code:
CE-BLUZA.260.BS



CLASSIC SWEATSHIRT

DESCRIPTION

Fabric	KNIT FABRIC 260
Cut	UNISEX
Sizes	2XS - 2XL
Neck	RIB CUFF
Sleeves	RIB CUFF
Bottom	RIB WELT
ESD sign	SIDE TAG

OPTIONS

Custom size	BESPOKE
Custom color	BESPOKE
Customer's logo	EMBROIDERY

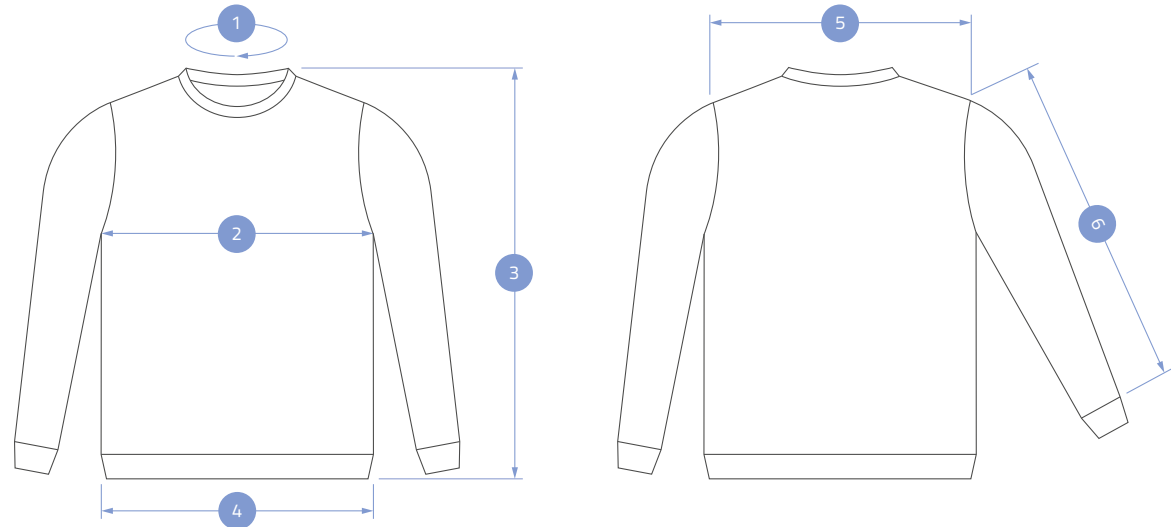

AVAILABLE COLORS | KNIT FABRIC 260

Light grey melange	Black	Navy blue	Blue
68	26	34	35

	2XS	XS	S	M	L	XL	2XL
BODY							
1	40	42	44	46	47	48	49
2	46	50	54	58	62	66	70
3	56	56	59	63	66	69	72
4	44	48	52	56	60	64	68
5	47	49	50	52	53	55	56
SLEEVES							
6	56	57	58	61	63	67	70

Dimensions in centimeters (cm) | Dimensional tolerance +/- 1.5 cm

49%
COTTON

49%
POLYESTER

2%
CARBON FIBER

Product code:
CE-BLUZA.260.UP



RESISTANCE IN ACCORDANCE
WITH STANDARD
PN-EN 61340-5-1



WEIGHT
260 g/m²



ZIP UP SWEATSHIRT

DESCRIPTION

Fabric	KNIT FABRIC 260
Cut	UNISEX
Sizes	2XS - 2XL
Fastener	COVERED ZIPPER
Neck	TURTLE NECK
Sleeves	RIB CUFF
Bottom	RIB WELT
ESD sign	SIDE TAG

OPTIONS

Custom size	BESPOKE
Custom color	BESPOKE
Customer's logo	EMBROIDERY

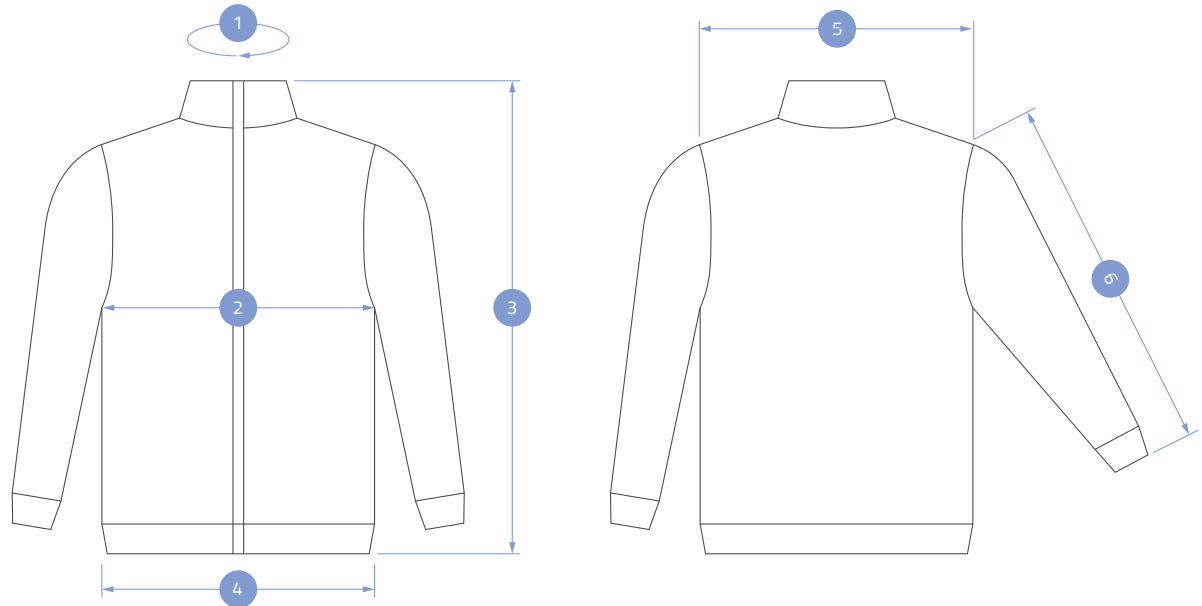

AVAILABLE COLOURS | KNIT FABRIC 260

Light grey melange	Black	Navy blue	Blue
68	26	34	35

	2XS	XS	S	M	L	XL	2XL
BODY							
1	36	40	40	42	43	45	47
2	52	55	58	61	64	67	70
3	74	76	78	80	82	84	86
4	42	45	48	51	54	57	60
5	45	46	47	48	49	50	51
SLEEVES							
6	66	68	70	74	76	78	80

Dimensions in centimeters (cm) | Dimensional tolerance +/- 1.5 cm

96%

POLYESTER

4%

CARBON
FIBER



RESISTANCE IN ACCORDANCE
WITH STANDARD

PN-EN 61340-5-1



WEIGHT

300 g/m²

Kod produktu:
CE-SOFTSHELL.SFTL



SOFTSHELL SWEATSHIRT

DESCRIPTION

Fabric	FABRIC SFTL
Cut	UNISEX
Sizes	2XS - 2XL
Fastener	COVERED ZIPPER
Neck	TURTLE NECK
Sleeves	RIB CUFF
Bottom	RIB WELT
ESD sign	SIDE TAG

OPTIONS

Custom size	BESPOKE
Custom color	BESPOKE
Customer's logo	EMBROIDERY

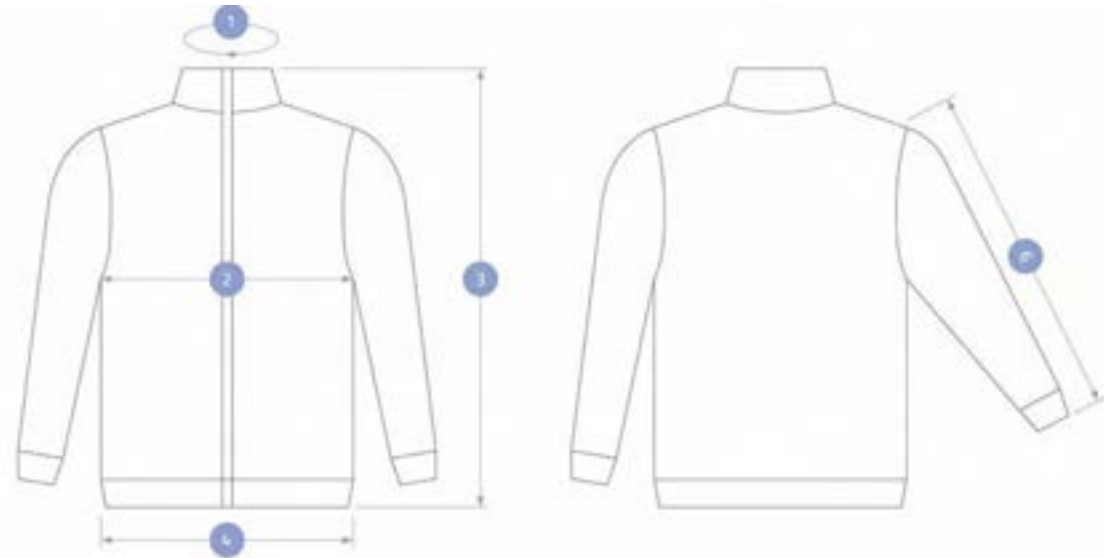

AVAILABLE COLORS | FABRIC SFTL



Black
37

	2XS	XS	S	M	L	XL	2XL
BODY							
1	36	40	40	42	43	45	47
2	52	55	56	58	60	62	64
3	70	71	71	72	72	73	73
4	48	49	51	53	55	57	59
SLEEVES							
5	64	65	65	67	68	70	73

Dimensions in centimeters (cm) | Dimensional tolerance +/- 1.5 cm

34%

COTTON

64%

POLYESTER

2%

CARBON FIBER



RESISTANCE IN ACCORDANCE
WITH STANDARD

PN-EN 61340-5-1



WEIGHT

160 g/m²

Product code:
CE-FARTU.065.D



WOMEN'S STANDARD COAT

DESCRIPTION

Fabric	FABRIC 065
Cut	FEMALE
Sizes	2XS - 2XL
Fastener	COVERED METAL SNAPS
Pockets	TWO ON THE BOTTOM ONE ON THE LEFT BREAST ONE ON THE LEFT SLEEVE
ESD sign	ON THE BREAST POCKET

OPTIONS

Custom size	BESPOKE
Custom color	BESPOKE
Customer's logo	EMBROIDERY

AVAILABLE COLOURS | FABRIC 065

STANDARD



White	Blue	Navy blue	Green	Black
01	02	03	04	22

NON-STANDARD



Yellow	Light grey	Dark grey	Red
06	14	29	60

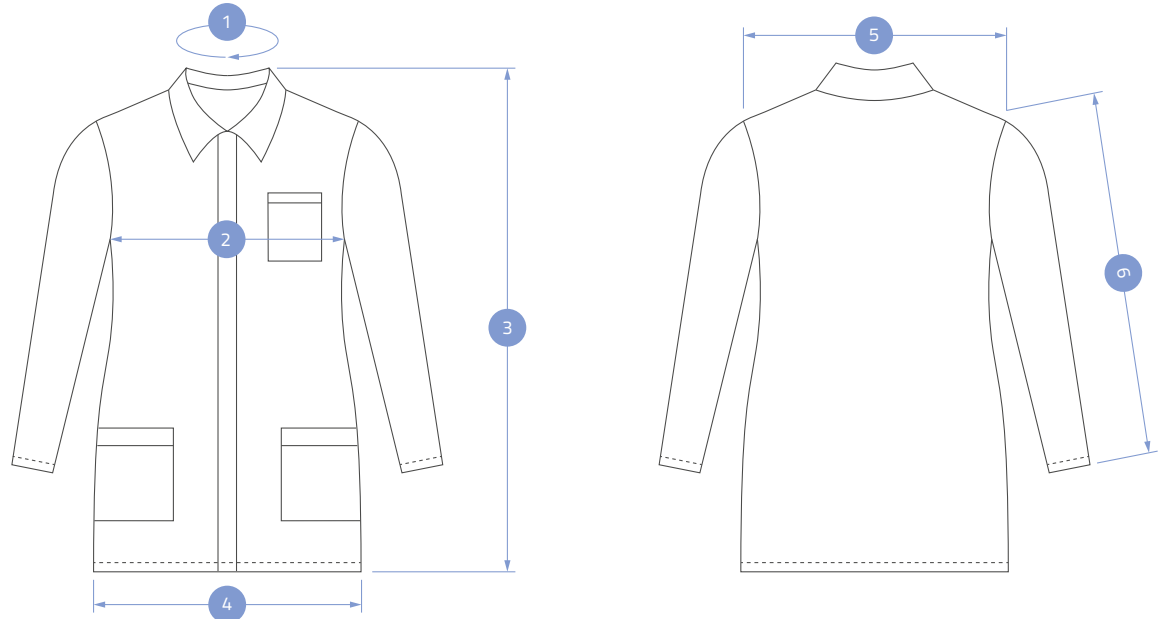

	2XS	XS	S	M	L	XL	2XL
BODY							
1	35	36	38	39	40	40	42
2	44	46	49	51	54	57	61
3	79	82	85	88	90	92	92
4	48	50	52	54	58	62	66
5	39	40	41	42	43	43	44
SLEEVES							
6	53	54	56	56	58	60	62

Dimensions in centimeters (cm) | Dimensional tolerance +/- 1.5 cm

34%

COTTON

64%

POLYESTER

2%

CARBON FIBER

Product code:
CE-FARTU.065



RESISTANCE IN ACCORDANCE
WITH STANDARD

PN-EN 61340-5-1



WEIGHT

160 g/m²



STANDARD COAT

DESCRIPTION

Fabric	FABRIC 065
Cut	UNISEX
Sizes	2XS - 2XL
Fastener	COVERED METAL SNAPS
Pockets	TWO ON THE BOTTOM ONE ON THE LEFT BREAST ONE ON THE LEFT SLEEVE
ESD sign	ON THE BREAST POCKET

OPTIONS

Custom size	BESPOKE
Custom color	BESPOKE
Customer's logo	EMBROIDERY

AVAILABLE COLOURS | FABRIC 065

STANDARD



White	Blue	Navy blue	Green	Black
01	02	03	04	22

NON-STANDARD



Yellow	Light grey	Dark grey	Red
06	14	29	60

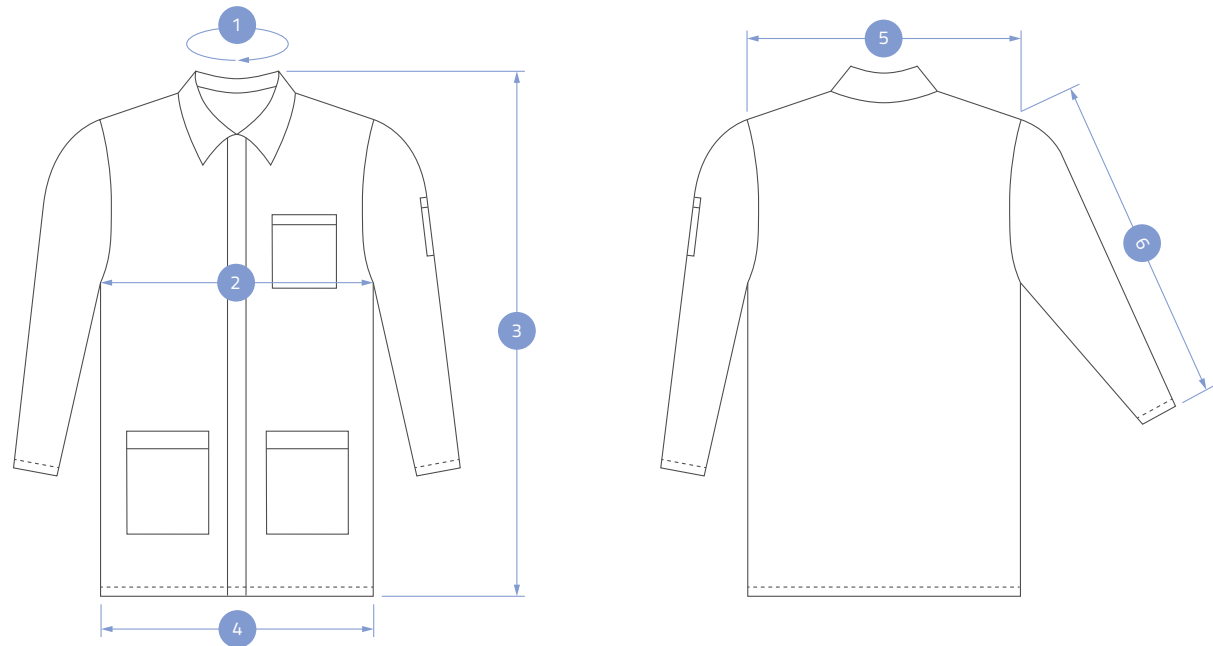

	2XS	XS	S	M	L	XL	2XL
BODY							
1	45	46	47	47	48	48	49
2	56	58	60	62	64	66	68
3	80	80	85	90	95	100	105
4	56	58	60	62	64	66	68
5	45	46	47	48	49	50	51
SLEEVES							
6	58	60	62	64	66	68	68

Dimensions in centimeters (cm) | Dimensional tolerance +/- 1.5 cm

95%

POLYESTER

5%

CARBON FIBER



RESISTANCE IN ACCORDANCE
WITH STANDARD

PN-EN 61340-5-1



WEIGHT

100 g/m²

Product code:

CE-FARTU.95



PREMIUM COAT

DESCRIPTION

Fabric	KNIT FABRIC 95
Cut	UNISEX
Sizes	2XS - 2XL
Fastener	COVERED METAL SNAPS
Pockets	TWO ON THE BOTTOM
Sleeves	FINISHED WITH ELASTIC INTERNAL HEM
ESD sign	SIDE TAG

OPTIONS

Custom size	BESPOKE
Custom color	BESPOKE
Customer's logo	EMBROIDERY

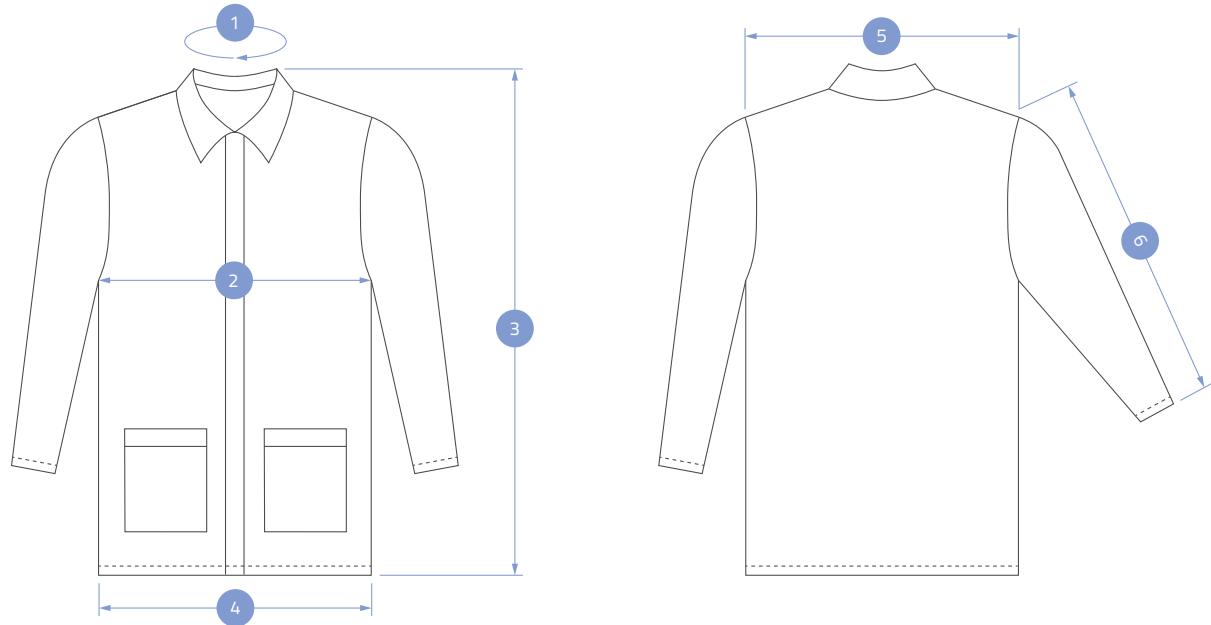

AVAILABLE COLOURS | KNIT FABRIC 95



Black

53

	2XS	XS	S	M	L	XL	2XL
BODY							
1	45	46	47	47	48	48	49
2	56	58	60	62	64	66	68
3	80	80	85	90	95	100	105
4	56	58	60	62	64	66	68
5	45	46	47	48	49	50	51
SLEEVES							
6	58	60	62	64	66	68	68

Dimensions in centimeters (cm) | Dimensional tolerance +/- 1.5 cm

34%

COTTON

64%

POLYESTER

2%

CARBON FIBER

Product code:
CE-SPODN.065.DAM



RESISTANCE IN ACCORDANCE
WITH STANDARD

PN-EN 61340-5-1



WEIGHT

160 g/m²



WOMEN'S TROUSERS

DESCRIPTION

Fabric	FABRIC 065
Cut	FEMALE
Sizes	36 - 48
Fastener	COVERED ZIPPER BUTTON AT THE WAIST
Pockets	TWO SIDE POCKETS ONE ON THE BACKSIDE
Legs	FINISHED WITH HEM
ESD sign	SIDE TAG

OPTIONS

Custom size	BESPOKE
Custom color	BESPOKE

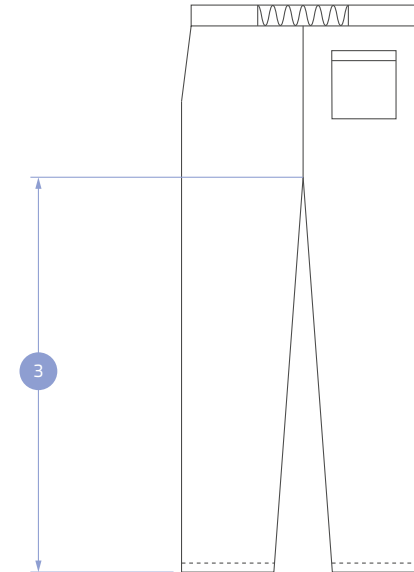
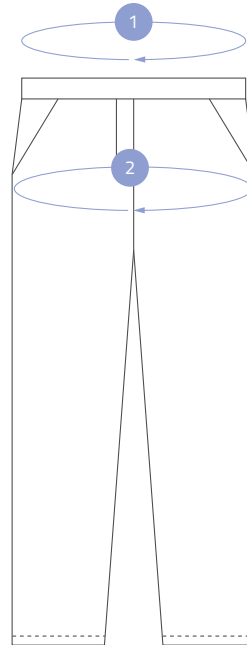

AVAILABLE COLOURS | FABRIC 065



Blue	Navy blue	Black	Dark grey
02	03	22	29

	36	38	40	42	44	46	48
1	68 - 72	72 - 76	76 - 80	80 - 84	84 - 88	88 - 92	92 - 96
2	45	47	49	51	53	55	58
3	72	72	73	73	74	74	75

Dimensions in centimeters (cm) | Dimensional tolerance +/- 1.5 cm

34%

COTTON

64%

POLYESTER

2%

CARBON FIBER

Product code:
CE-SPODN.065.MES



RESISTANCE IN ACCORDANCE
WITH STANDARD

PN-EN 61340-5-1



WEIGHT

160 g/m²



MEN'S TROUSERS

DESCRIPTION

Fabric	FABRIC 065
Cut	MALE
Sizes	44 - 60
Fastener	COVERED ZIPPER BUTTON AT THE WAIST
Pockets	TWO SIDE POCKETS ONE ONE THE BACKSIDE ONE ON THE RIGHT THIGH
Legs	FINISHED WITH HEM
ESD sign	SIDE TAG

OPTIONS

Custom size	BESPOKE
Custom color	BESPOKE

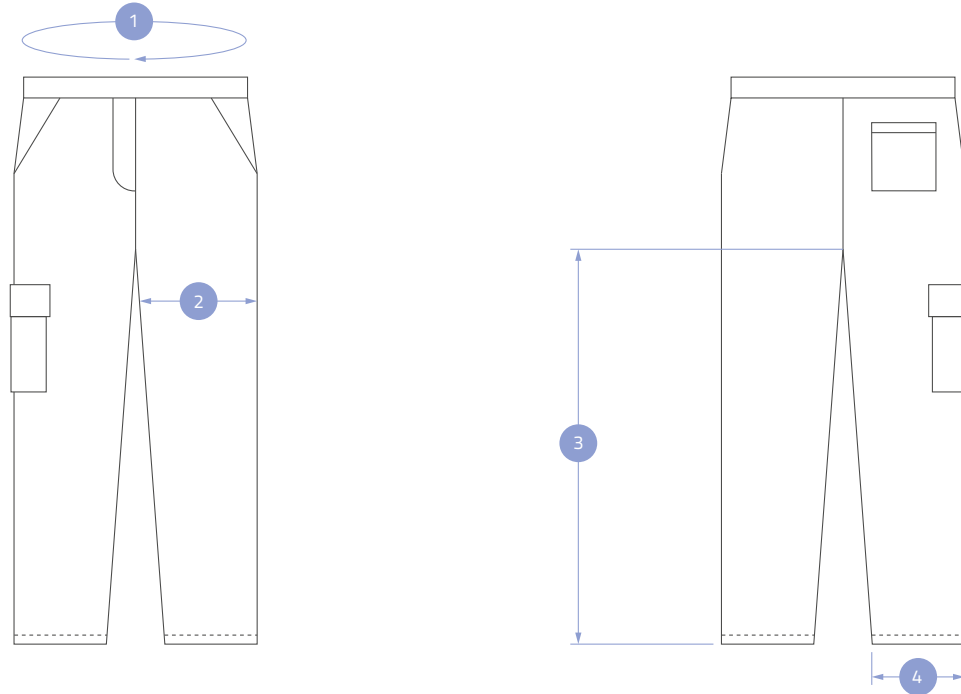

AVAILABLE COLOURS | FABRIC 065



Blue	Navy blue	Black	Dark grey
02	03	22	29

	44	46	48	50	52	54	56	58	60
1	78	82	86	90	94	98	102	106	110
2	28	30	31	32	33	34	35	36	37
3	82	82	82	82	82	82	84	84	84
4	21	22	23	24	25	26	27	28	29

Dimensions in centimeters (cm) | Dimensional tolerance +/- 1.5 cm





CLEANROOM CLOTHING

Cleanroom is a special clean zone in which the working environment is kept with the least level of pollution. In fact the most common cause of contamination in Cleanroom area are people whose improper behavior or inappropriate clothing interrupts the proper functioning of the clean zone, and in extreme cases destroys the final effect of the work carried out.

Based on many years of experience, we have developed Cleanroom clothing.

REECO ESD Cleanroom clothing is sewn from dust free polyester, which properties have been confirmed by competent tests.

The proposed types of clothing are intended for multiple use while maintaining appropriate washing and storage conditions.

We suggest our clients to service clothing in specialized laundries.

Our clothing is reusable and can be industrially washed. REECO brand clothing is widely used, in particular in such industries as electronic, automotive and pharmaceutical.

99%

POLYESTER

1%

CARBON FIBER



RESISTANCE IN ACCORDANCE
WITH STANDARD

PN-EN 61340-5-1



WEIGHT

110 g/m²

Product code:

CE-FARTU.099



CLEANROOM COAT

DESCRIPTION

Fabric	FABRIC 099
Cut	UNISEX
Sizes	2XS - 2XL
Fastener	COVERED METAL SNAPS
Pockets	INTERNAL: ONE ON THE LEFT BREAST TWO ON THE BOTTOM
Sleeves	FINISHED WITH ELASTIC HEM
ESD sign	INTERNAL TAG

OPTIONS

Custom size	BESPOKE
Custom color	BESPOKE
Fastener	ZIPPER
Pockets	NONE

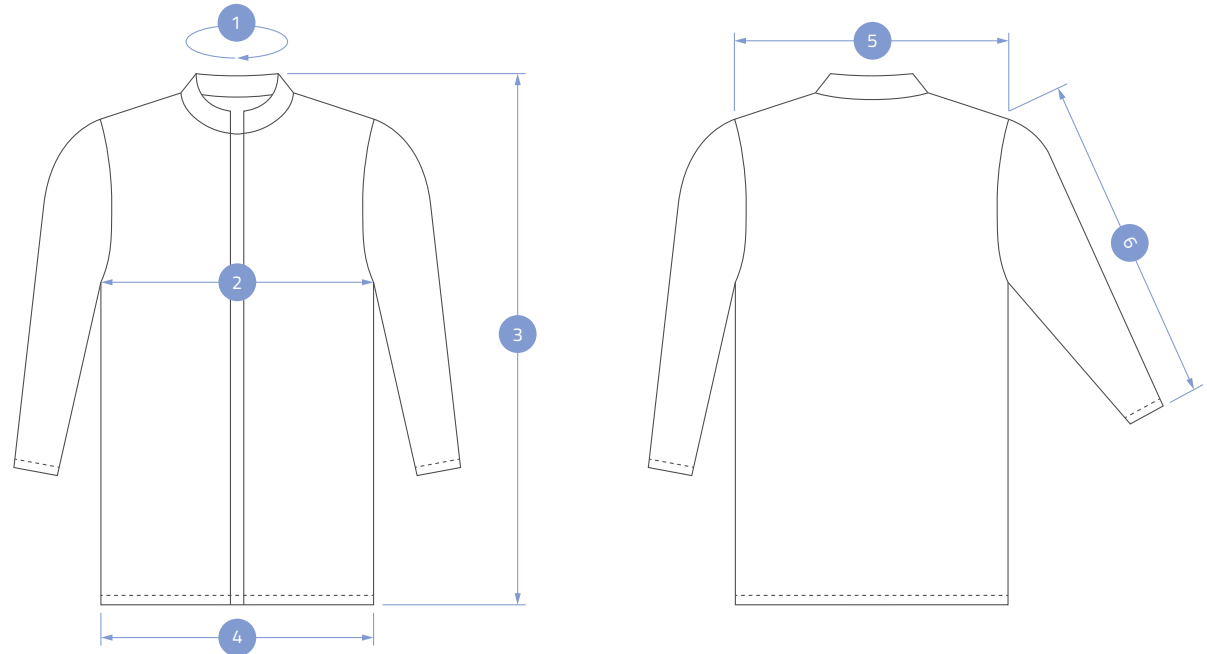

AVAILABLE COLOURS | FABRIC 099



White	Light grey	Navy blue	Blue	Dark green	Lemon green
08	09	10	15	16	18

	2XS	XS	S	M	L	XL	2XL
BODY							
1	44	45	46	47	48	49	50
2	55	57	60	63	65	67	69
3	90	95	100	105	110	115	120
4	55	57	60	63	65	67	69
5	45	46	47	48	49	50	51
SLEEVES							
6	58	58	60	62	64	64	66

Dimensions in centimeters (cm) | Dimensional tolerance +/- 1.5 cm

99%

POLYESTER

1%

CARBON FIBER

Product code:

[CE-FARTU.099.KAP](#)



RESISTANCE IN ACCORDANCE
WITH STANDARD

PN-EN 61340-5-1



WEIGHT

110 g/m²



CLEANROOM HOODED COAT

DESCRIPTION

Fabric	FABRIC 099
Cut	UNISEX
Sizes	2XS - 2XL
Fastener	COVERED ZIPPER
Sleeves	RIB CUFF
ESD sign	INTERNAL TAG

OPTIONS

Custom size	BESPOKE
Custom color	BESPOKE

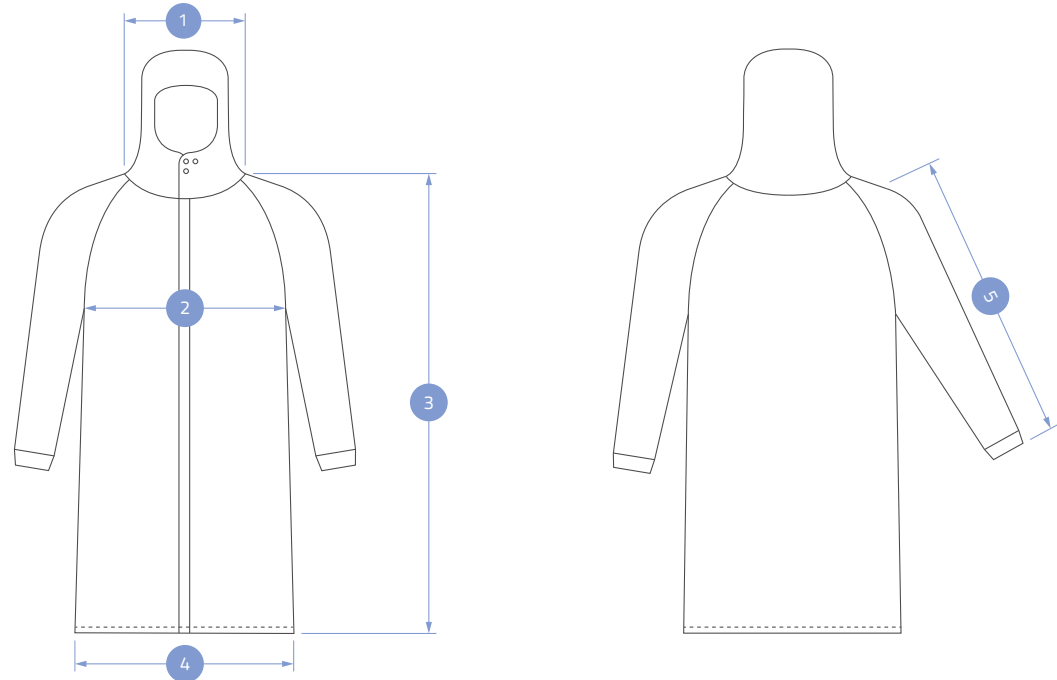

AVAILABLE COLOURS | FABRIC 099



White	Light grey	Navy blue	Blue	Dark green	Lemon green
08	09	10	15	16	18

	2XS	XS	S	M	L	XL	2XL
BODY							
1	18	18	18	18	18	18	18
2	54	58	62	66	70	74	78
3	102	103	104	105	106	107	108
4	56	60	64	68	70	74	78
SLEEVES							
5	79	80	81	82	83	84	85

Dimensions in centimeters (cm) | Dimensional tolerance +/- 1.5 cm

99%

POLYESTER

1%

CARBON FIBER



RESISTANCE IN ACCORDANCE
WITH STANDARD

PN-EN 61340-5-1



WEIGHT

110 g/m²

Product code:

CE-KOMBI.099



CLEAN ROOM COVERALL

DESCRIPTION

Fabric	FABRIC 099
Cut	UNISEX
Sizes	2XS - 2XL
Fastener	COVERED ZIPPER
Sleeves	FINISHED WITH ELASTIC HEM
Legs	FINISHED WITH ELASTIC HEM
Waist	ADJUSTABLE WELT
Hood	SEPARATED FROM THE COVERALL ADJUSTABLE TIED UNDER THE ARMS
ESD sign	INSIDE

OPTIONS

Custom size	BESPOKE
Custom color	BESPOKE
Hood	INTEGRATED WITH COVERALL

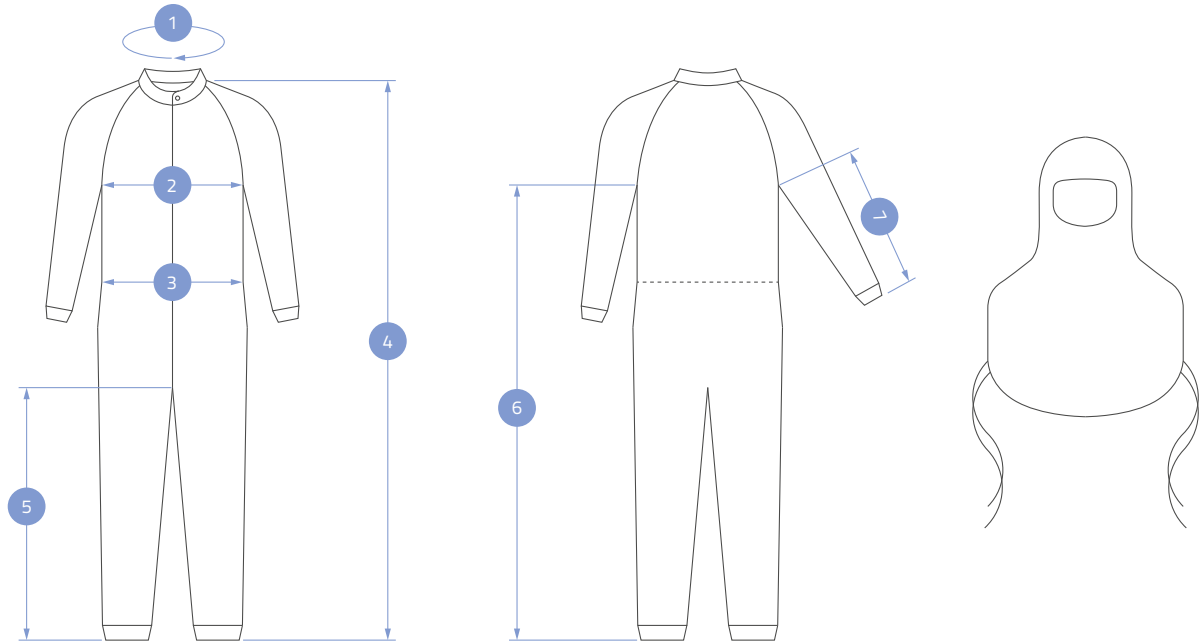

AVAILABLE COLOURS | FABRIC 099



White

08

Blue



























15

	2XS	XS	S	M	L	XL	2XL
BODY							
1	47	47	48	51	52	53	54
2	51	55	59	63	67	71	75
3	42	46	50	54	58	62	66
4	164	165	166	169	171	173	175
5	78	78	79	81	81	82	82
6	132	133	134	136	137	138	138
SLEEVES							
7	60	61	62	63	64	65	65

Dimensions in centimeters (cm) | Dimensional tolerance +/- 1.5 cm



REECO CLOTHING WASHING INSTRUCTIONS

	FABRIC 065	FABRIC 099	PIQUE KNIT FABRIC	KNIT FABRIC 050	KNIT FABRIC 260	KNIT FABRIC 95	FABRIC SFTL
WASHING TEMPERATURE	 Wash at 60°C	 Wash at 60°C	 Wash at 40°C	 Wash at 40°C	 Wash at 40°C	 Wash at 40°C	 Wash at 40°C
BLEACHING	 Do not bleach	 Do not bleach	 Do not bleach	 Do not bleach	 Do not bleach	 Do not bleach	 Do not bleach
DRYING	 Tumble dry low temperature	 Tumble dry low temperature	 Tumble dry low temperature	 Tumble dry low temperature	 Tumble dry low temperature	 Tumble dry low temperature	 Do not tumble dry
IRONING	 Max sole-plate temp. 150	 Max sole-plate temp. 150	 Max sole-plate temp. 120	 Max sole-plate temp. 120	 Max sole-plate temp. 120	 Max sole-plate temp. 120	 Max sole-plate temp. 120
DRY CLEANING	 Do not dry clean	 Do not dry clean	 Do not dry clean	 Do not dry clean	 Do not dry clean	 Do not dry clean	 Do not dry clean



The effectiveness of antistatic protective clothing may be affected by: wear, damage, laundry and possible contamination. We recommend washing clothes in controlled conditions.

COOPERATION

Since 2009 we've been offering REECO ESD Antistatic Clothing based on three sales channels:



END USERS

We deliver our products to small and medium -sized companies as well as to large corporations and individuals persons.

REECO clothing is used in many industries, in particular: electronic, automotive, food, pharmaceutical and hazardous areas EX.



CLOTHING RENTAL SERVICES

We have more than 10 years of experience in cooperation with companies providing laundry and clothing service both in Poland and abroad.

We provide product and subject-specific training.



DISTRIBUTION

We work with distributors of workwear and personal protection equipment, both in Poland and abroad.

REECO clothing is sold by our partners among others in Germany, France, Romania, USA as well as in Italy and the United Kingdom.

We guarantee professional help, product trainings and joint visits with clients.



HEADQUARTERS - POLAND

Al. Kazimierza Wielkiego 6E
87-800 Włocławek, POLAND

T: + 48 54 427 04 00
E: office@reeco.info

Product Manager

T: + 48 726 111 150
E: esdclothing@reeco.info

ODDZIAŁY ZAGRANICZNE

SERBIA

Kneza Mihajla Obrenovića 25
26000 Pančevo, SERBIA

T: + 381 13 23 17 880
E: serbia@reeco.info

ROMANIA | BULGARIA

Strada Văliug, nr. 32, Sector 1
13986 București, ROMANIA

T: + 40 799 774 330
E: romania@reeco.info

CROATIA | SLOVENIA

Ulica grada Vukovara 271
10000 Zagreb, CROATIA

T: + 385 99 44 89 666
E: croatia@reeco.info

BULGARIA

Botevgradsko Logistics Park
blvd. Botevgradsko Shose 228
1839 Sofia, BULGARIA

T: + 359 877 066 363
E: office@renex.bg

WWW.REECO.INFO

